

(19)



Europäisches Patentamt
European Patent Office
Office européen des brevets



(11)

EP 1 132 061 B1

(12)

EUROPEAN PATENT SPECIFICATION

(45) Date of publication and mention
of the grant of the patent:
18.08.2004 Bulletin 2004/34

(51) Int Cl.7: **A61F 2/28, A61F 2/44**

(21) Application number: **01302070.6**

(22) Date of filing: **07.03.2001**

(54) **Polymer filled spinal fusion cage**

Polymer-gefüllter Wirbelsäulefusionskäfig
CAGE DE FUSION spinale remplie de polymère

(84) Designated Contracting States:
DE ES FR GB IT

• **Lozier, Antony J.**
Warsaw, IN 46582 (US)

(30) Priority: **07.03.2000 US 520893**

(74) Representative: **Mays, Julie et al**
Barker Brettell,
10-12 Priests Bridge
London SW15 5JE (GB)

(43) Date of publication of application:
12.09.2001 Bulletin 2001/37

(73) Proprietor: **Zimmer Technology, Inc.**
Chicago, Illinois 60606 (US)

(56) References cited:
EP-A- 0 398 497 **WO-A-98/20939**
FR-A- 2 639 823 **US-A- 5 549 679**
US-A- 5 571 204 **US-A- 5 827 289**
US-A- 5 888 220 **US-A- 5 968 999**

(72) Inventors:
• **Stalcup, Gregory C**
Columbia City, IN 46725 (US)

EP 1 132 061 B1

Note: Within nine months from the publication of the mention of the grant of the European patent, any person may give notice to the European Patent Office of opposition to the European patent granted. Notice of opposition shall be filed in a written reasoned statement. It shall not be deemed to have been filed until the opposition fee has been paid. (Art. 99(1) European Patent Convention).

Description**BACKGROUND OF THE INVENTION****1. Field of the invention.**

[0001] The present invention relates to orthopaedic implants, and, more particularly, to spinal fusion devices.

2. Description of the related art.

[0002] Spinal fusion typically involves fusion between two adjacent vertebrae by removing a disc between two adjacent vertebrae and placing a cage between the vertebrae. The patient may be cut both on the anterior and posterior sides (stomach and back) and the disc removed from between the two adjacent vertebrae. The disc includes an annulus which surrounds a nucleus. The annulus is torn, cut or otherwise removed from between the vertebrae and the softer nucleus also removed. A cage is placed between the vertebrae where the disc is removed and a bone graft including bone particles is packed within the cage and extends between the end plates of the adjacent vertebrae. Rods may also be placed on the posterior side of the spine, with screws attached to a respective rod and extending into a respective vertebrae. US-A-5 888 220 discloses a method and related apparatus for using minimally invasive techniques to repair tissue by the use of an inflatable balloon that may also be used with a curable biomaterial. EP-A-0 398 497 discloses a method and related apparatus for forming an implant precursor and an implant in situ.

SUMMARY OF THE INVENTION

[0003] The present invention provides an orthopaedic implant including a bag which is placed within a cavity surrounded by an annulus of a disc and which includes a central cavity. The bag is filled with a polymer, and the central cavity defined by the bag is filled with a bone particle and polymer matrix. The invention comprises, in one form thereof, an orthopaedic implant for implanting between adjacent vertebrae in a spine, including an essentially annular bag; and a hardened polymer within the bag.

[0004] The description discloses a method of fusing adjacent vertebrae in a spine, including the steps of forming an access hole in an annulus of a disc between the adjacent vertebrae; removing the nucleus within the disc to form a cavity surrounded by the annulus; placing an essentially annular bag within the cavity; filling the bag with a polymer; injecting bone particles into the cavity surrounded by the annular bag and hardening the polymer.

[0005] An advantage of the present invention is that an orthopaedic implant may be implanted between adjacent vertebrae in a spine in a minimal evasive surgery

technique.

[0006] Another advantage is that the ligaments and tendons surrounding the spine may be properly tensioned.

5 [0007] Yet another advantage is that the patient may begin loading the implant soon after surgery.

[0008] A still further advantage is that the implant may be implanted from a single posterior incision location, or may be implanted from a posterior and/or anterior incision location.

BRIEF DESCRIPTION OF THE DRAWINGS

[0009] The above-mentioned and other features and advantages of this invention, and the manner of attaining them, will become more apparent and the invention will be better understood by reference to the following description of an embodiment of the invention taken in conjunction with the accompanying drawings, wherein:

15 Fig. 1 is a fragmentary, sectional view of a vertebrae and disc, illustrating an orientation and size of an incision made relative thereto;

Fig. 2 is a perspective view illustrating evacuation of a nucleus within a disc;

25 Fig. 3 is a perspective view illustrating placement of an annular bag within a disc;

Fig. 4 is a perspective view of the bag in a relaxed state after being placed within the disc;

30 Fig. 5 is a side, sectional view of the bag while being filled with a polymer to a first predetermined amount;

Fig. 6 is a side, sectional view illustrating a bone particle and polymer matrix being injected into a cavity surrounded by the bag;

35 Fig. 7 is a side, sectional view illustrating the bag being filled to a second predetermined amount after injection of bone particles;

40 Fig. 8 is a fragmentary, sectional view with the orthopaedic implant implanted within a disc and the incision being closed;

Fig. 9 is a perspective view of the bag shown in Figs. 4-9; and

45 Fig. 10 is a side, sectional view of the bag shown in Figs. 4-10.

[0010] Corresponding reference characters indicate corresponding parts throughout the several views. The exemplification set out herein illustrates one preferred embodiment of the invention, in one form, and such exemplification is not to be construed as limiting the scope of the invention in any manner.

DETAILED DESCRIPTION OF THE INVENTION

55 [0011] Referring now to the drawings, an embodiment of the method for fusing adjacent vertebrae in a spine will be described hereinafter. The spine includes a plu-

rality of adjacent vertebrae 10, which each adjacent pair of vertebrae 10 being separated by a disc 12. A disc 12 may become damaged because of a number of reasons, thus requiring the fusion of adjacent vertebrae.

[0012] Fig. 1 illustrates a fragmentary, sectional view of a spine as viewed in a direction parallel to the spine of a patient. Disc 12 is assumed to be damaged to an extent requiring fusion between adjacent vertebrae 10. Referring to Fig. 2., each vertebrae 10 includes oppositely facing end plates 24 on each longitudinal end thereof. Each disc 12 is interposed between a pair of adjacent vertebrae, and includes an annulus 26 surrounding a nucleus 28.

[0013] An incision 14 is made in the back 16 of the patient using a scalpel 18 or other appropriate cutting instrument. Incision 14 may be held open using suitable instrumentation 20. Incision 14 is made at an angle approximately as shown to disc 12, thereby avoiding an area 22 where the spinal cord is located. After incision 14 is made, an access hole 30 is formed in an annulus 26 of a selected disc 12 by known methods such as a drill bit or scalpel. Since incision 14 is formed in the back 16 of the patient, access hole 30 generally is formed in the posterior side of disc 12.

[0014] After formation of access hole 30, the nucleus 28 is evacuated from within disc 12 (Fig. 3). A vacuum tube 34 or the like may be used to remove nucleus 28. Removal of nucleus 28 causes the formation of a cavity 42 within disc 12 surrounded by annulus 26. Vacuum tube 34 is removed from cavity 42 and incision 14 after evacuation of nucleus 28.

[0015] A flexible bag 44 having an essentially annular shape when in a relaxed state is then inserted within cavity 42 (Fig. 4). More particularly, bag 44 is folded and inserted within a pre-load tube 46. Pre-load tube 46 has an outside diameter which is slightly smaller than the inside diameter of access hole 30 formed in annulus 26. Pre-load tube 46, with bag 44 loaded therein, is inserted into incision 14 and access hole 30 such that an end 48 of pre-load tube 46 extends through access hole 30 and into cavity 42. Bag 44 is then slid out of pre-load tube 46 and into cavity 42 as indicated by arrows 50. Bag 44 may be ejected from pre-load tube 46 in any suitable manner, such as by utilizing a plunger (not shown) disposed within pre-load tube 46 having an outside diameter which is slightly smaller than the inside diameter of pre-load tube 46.

[0016] Bag 44 is selected with a size and shape to generally fill the perimeter of cavity 42 when disposed therein (Fig. 5). A first fill hose 52 and a second fill hose 54 are each attached to bag 44 (Figs. 5-11). First fill hose 52 extends through bag 44 and terminates in a portion of cavity 42 surrounded by bag 44 (Fig. 6). On the other hand, second fill hose 54 extends into and terminates within bag 44. A high strength polymer is injected within bag 44 through second fill hose 54, as indicated by arrows 56. During this first fill stage of bag 44, the polymer 58 is injected to substantially fill bag 44 to a first pre-

5 terminated amount without expanding or deforming bag 44. In the embodiment shown, bag 44 is porous and polymer 58 is in the form of a bioresorbable and curable polymer, some of which passes through bag 44. The curing can be effected by the application of energy such as thermal energy, light energy, or X-ray energy, or the addition of a chemical catalyst. During the first fill stage of bag 44 shown in Fig. 6, polymer 58 preferably remains in an uncured state.

10 [0017] A bone graft in the form of bone particles 60 is then injected through first fill hose 52 into the portion of cavity 42 surrounded by bag 44 (Fig. 7), as indicated by arrows 62. It should be understood that a bone substitute material can also be used. In the embodiment shown, bone particles 60 are suspended within a liquid such as synthetic bone substitute. The bone particle and suspension liquid is injected through first fill hose 52 and into cavity 42 until the portion of cavity 42 surrounded by bag 44 is substantially filled as shown in Fig. 7. Thereafter, bone particles 60 are retained within cavity 42 and additional polymer 58 is injected into bag 44 (Fig. 8). Polymer 58 is injected into bag 44 to a second predetermined amount causing expansion of bag 44. Bag 44 expands in an axial direction (relative to disc 12) and contacts end plates 24. Additionally, bag 44 expands in a radially inward direction causing radial compression and axial expansion of bone particles 60 within cavity 42. The ligaments and tendons surrounding vertebrae 10 may thus be retensioned by axially expanding bone particles 60 therebetween. Additionally, the fusion area is provided with a large contact area since substantially all of the area contacted by bone particles 60 and bag 44 forms a load bearing member. The polymer compound 58 within bag 44, as well as the polymer surrounding and carrying bone particles 60 may be cured to a load bearing state in a relatively fast manner. For example, the polymer compound may be cured with X-ray energy or a chemical catalyst. Thus, in addition to being minimally evasive, the patient is able to quickly load the spine through sitting, standing, etc. after curing of the polymer within orthopaedic implant 8. First fill hose 52 and second fill hose 54 are cut from orthopaedic implant 8, as indicated in Fig. 9, and incision 14 is closed using suitable closure techniques.

45 [0018] From the foregoing description, it can be seen that the present invention provides an orthopaedic implant 8 which may be easily implanted within a disc 12 with minimal evasive surgical procedures. The curing of the polymer within the bag between the adjacent vertebrae 10 occurs quickly and provides a large surface area for transfer of loads and a stable structure for the re-growth of bone between the vertebrae.

50 [0019] Furthermore, the present invention can be used in a method of fusing adjacent vertebrae in a spine, comprising the steps of:

55 forming an access hole in an annulus of a disc between the adjacent vertebrae;

removing the nucleus within the disc to form a cavity surrounded by said annulus;
 placing a generally annular bag within said cavity;
 filling said bag with a polymer;
 injecting bone particles into a portion of said cavity surrounded by said annular bag; and
 hardening said polymer. Suitably, said filling step may comprise filling said bag with said polymer to a first predetermined amount, and may comprise the further step of filling said bag with said polymer to a second predetermined amount, said second filling step occurring after said injecting step. Desirably, said second filling step may compress said bone particles in a radially inward direction into a column, and may expand said column in an axial direction. Suitably, said expansion of said bone particles in said axial direction may load said bone particles against an end plate of each respective said adjacent vertebrae. Desirably, said second filling step may provide height adjustment of said disc between said adjacent vertebrae.

[0020] In the method, said bone particles may comprise bone chips. Furthermore, said bone particles may be suspended within a matrix. Desirably, said forming step may comprise forming said access hole in a side of said disc. Suitably, said removing step may comprise evacuating said nucleus from said disc.

[0021] In the method, said placing step may comprise the sub-steps of folding said bag;

inserting said folded bag within a pre-load tube;
 inserting at least an end of said pre-load tube into said cavity; and
 pushing said folded bag from said pre-load tube into said cavity.

[0022] In the above-described methods said filling step may comprise injecting said polymer under pressure into said bag. Desirably, said bag may be expandable under said pressure. Suitably, said polymer may comprise a curable polymer. Furthermore, said polymer may be curable with one of thermal energy, light energy, X-ray energy and a chemical catalyst.

[0023] In the method, said hardening step may comprise hardening said polymer with a chemical catalyst. Furthermore, said bag may comprise a porous bag allowing some of said polymer to pass therethrough.

Claims

1. An orthopaedic implant for implanting between adjacent vertebrae comprising
 a flexible container (44); and
 a hardened polymer (58) within the container (44),

characterised in that the container (44) is essentially annular.

2. An orthopaedic implant precursor comprising
 a flexible, container (44); and
 a hardenable polymer (58) within the container (44),
 characterised in that the container is essentially annular.
3. An orthopaedic implant, or precursor thereof, according to claim 1 or 2, characterised in that it further comprises a fill tube (54) connected with said container (44) for injecting said polymer (58) into said container (44).
4. An orthopaedic implant, or precursor thereof, according to any preceding claim, characterised in that said polymer (58) comprises a curable polymer.
5. An orthopaedic implant, or precursor thereof, according to claim 4, characterised in that said polymer (58) is curable with one of thermal energy, light energy, X-ray energy and a chemical catalyst.
6. An orthopaedic implant, or a precursor thereof, according to any preceding claim, characterised in that said polymer (58) comprises polymethyl-ethacrylate.
7. An orthopaedic implant, or precursor thereof, according to any preceding claim, characterised in that said container (44) comprises a porous container allowing some of said polymer (58) to pass therethrough.
8. A kit for an orthopaedic implant precursor characterised in that it comprises:
 - i) a container (44) as defined in any one of claims 1, 2, 3 or 7; and
 - ii) a hardenable polymer (58) as defined in any one of claims 2, 4, 5 or 6.
9. A kit according to claim 8 characterised in that it further comprises means for hardening the polymer.
10. The use of a hardenable polymer (58) or the use of a kit according to claims 8 or 9 for the manufacture of a precursor according to claim 2 and any one of claims 3 to 7.

Patentansprüche

1. Orthopädisches Implantat zum Implantieren zwischen Nachbarwirbeln mit einem flexiblen Behälter (44); und einem gehärteten Polymer (58) im Behälter (44), **dadurch gekennzeichnet, daß** der Behälter (44) im wesentlichen ringförmig ist. 5
2. Orthopädischer Implantatvorläufer mit einem flexiblen Behälter (44); und einem härtbaren Polymer (58) im Behälter (44), **dadurch gekennzeichnet, daß** der Behälter (44) im wesentlichen ringförmig ist. 10
3. Orthopädisches Implantat oder Vorläufer davon nach Anspruch 1 oder 2, **dadurch gekennzeichnet** es (er) ferner einen mit dem Behälter (44) verbundenen Füllschlauch (54) zum Injizieren des Polymers (58) in den Behälter (44) aufweist. 15
4. Orthopädisches Implantat oder Vorläufer davon nach einem der vorstehenden Ansprüche, **dadurch gekennzeichnet, daß** das Polymer (58) ein härtbares Polymer aufweist. 20
5. Orthopädisches Implantat oder Vorläufer davon nach Anspruch 4, **dadurch gekennzeichnet, daß** das Polymer (58) mit Wärmeenergie, Lichtenergie, Röntgenenergie oder einem chemischen Katalysator härtbar ist. 25
6. Orthopädisches Implantat oder Vorläufer davon nach einem der vorstehenden Ansprüche, **dadurch gekennzeichnet, daß** das Polymer (58) Polymethylmethacrylat aufweist. 30
7. Orthopädisches Implantat oder Vorläufer davon nach einem der vorstehenden Ansprüche, **dadurch gekennzeichnet, daß** der Behälter (44) einen porösen Behälter aufweist, durch den ein Teil des Polymers (58) durchgehen kann. 40
8. Bausatz für einen orthopädischen Implantatvorläufer, **dadurch gekennzeichnet, daß** er aufweist: 45
 - i) einen Behälter (44) nach einem der Ansprüche 1, 2, 3 oder 7; und
 - ii) ein härtbares Polymer (58) nach einem der Ansprüche 2, 4, 5 oder 6.
9. Bausatz nach Anspruch 8, **dadurch gekennzeichnet, daß** er ferner eine Einrichtung zum Härten des Polymers aufweist. 50
10. Verwendung eines härtbaren Polymers (58) oder Verwendung eines Bausatzes nach Anspruch 8 oder 9 zur Herstellung eines Vorläufers nach Anspruch 2 und einem der Ansprüche 3 bis 7. 55

Revendications

1. Un implant orthopédique à implanter entre des vertèbres adjacentes comprenant un récipient souple (44); et un polymère durci (58) contenu dans le récipient (44), **caractérisé en ce que** le récipient (44) est essentiellement annulaire. 5
2. Un précurseur d'implant orthopédique comprenant un récipient souple (44); et un polymère durcissable (58) contenu dans le récipient (44), **caractérisé en ce que** le récipient est essentiellement annulaire. 10
3. Un implant orthopédique, ou son précurseur, selon la revendication 1 ou 2, **caractérisé en ce qu'il** comprend en outre un tube de remplissage (54) relié audit récipient (44) pour injecter ledit polymère (58) dans ledit récipient (44). 15
4. Un implant orthopédique, ou son précurseur, selon une revendication précédente quelconque, **caractérisé en ce que** ledit polymère (58) comprend un polymère durcissable. 20
5. Un implant orthopédique, ou son précurseur, selon la revendication 4, **caractérisé en ce que** ledit polymère (58) est durcissable par l'une parmi l'énergie thermique, l'énergie lumineuse, l'énergie des rayons X et un catalyseur chimique. 25
6. Un implant orthopédique, ou son précurseur, selon une revendication précédente quelconque, **caractérisé en ce que** ledit polymère (58) comprend le polyméthacrylate de méthyle. 30
7. Un implant orthopédique, ou son précurseur, selon une revendication précédente quelconque, **caractérisé en ce que** ledit récipient (44) comprend un récipient poreux permettant qu'une certaine quantité dudit polymère (58) le traverse. 40
8. Un kit pour un précurseur d'implant orthopédique **caractérisé en ce qu'il** comprend : 45
 - i) un récipient (44) tel que défini par l'une quelconque des revendications 1, 2, 3 ou 7; et
 - ii) un polymère durcissable (58) tel que défini par l'une quelconque des revendications 2, 4, 5 ou 6.
9. Un kit selon la revendication 8 **caractérisé en ce qu'il** comprend en outre un moyen pour durcir le polymère. 50
10. L'utilisation d'un polymère durcissable (58) ou l'utilisation d'un kit selon la revendication 8 ou 9, pour 55

la fabrication d'un précurseur selon la revendication
2 et l'une quelconque des revendications 3 à 7.

5

10

15

20

25

30

35

40

45

50

55

6

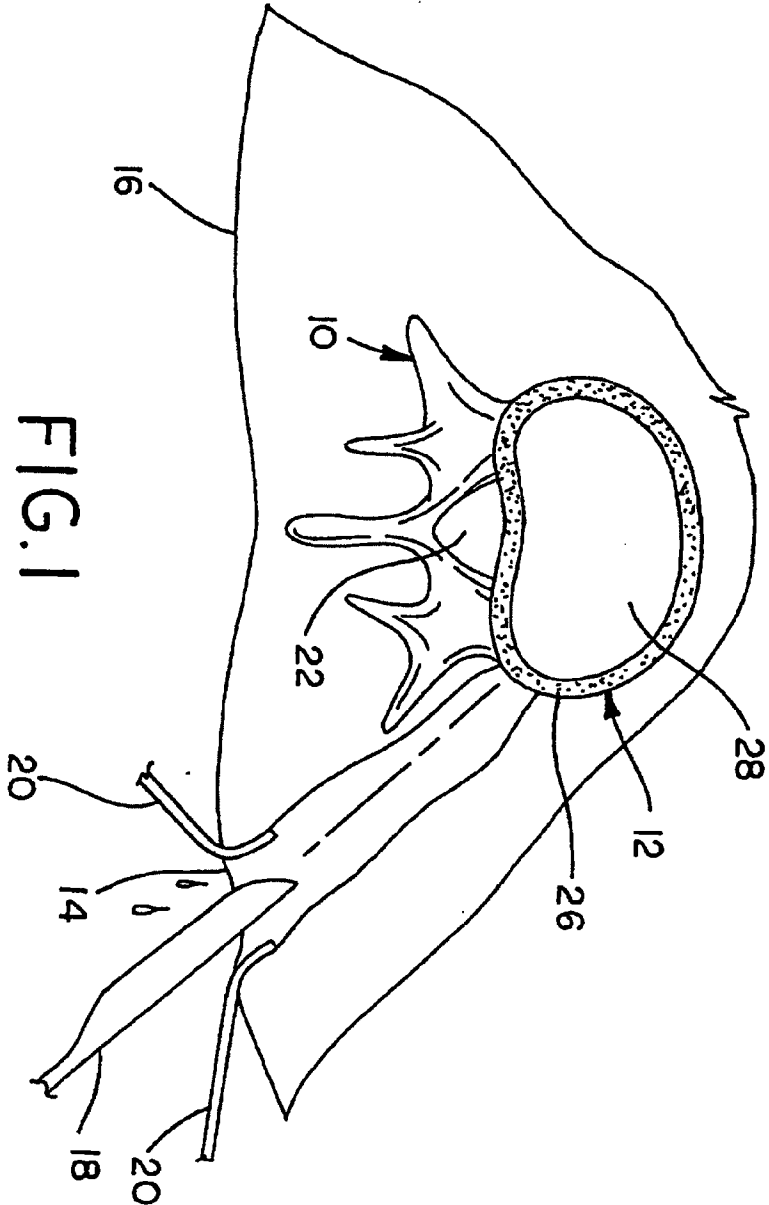

FIG. 1

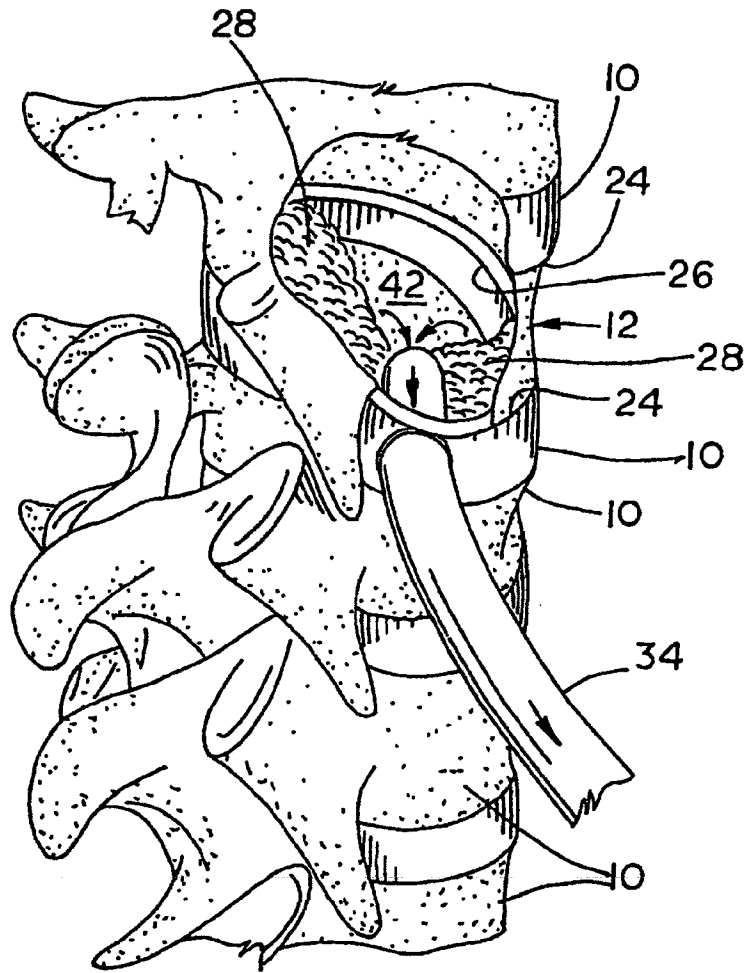

FIG.2

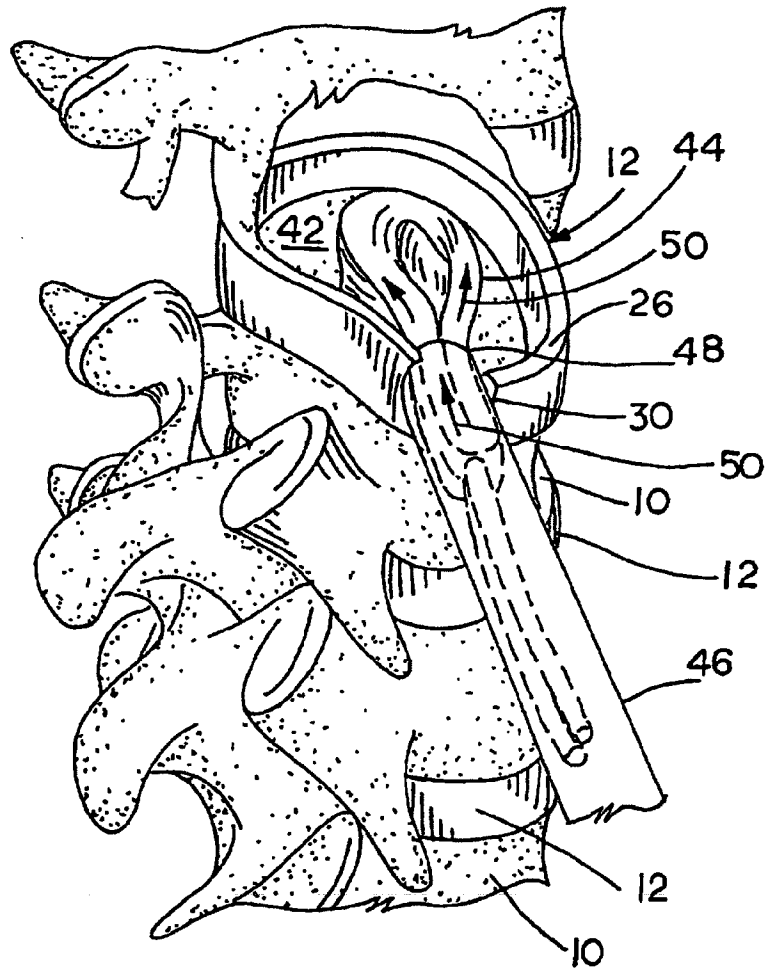

FIG. 3

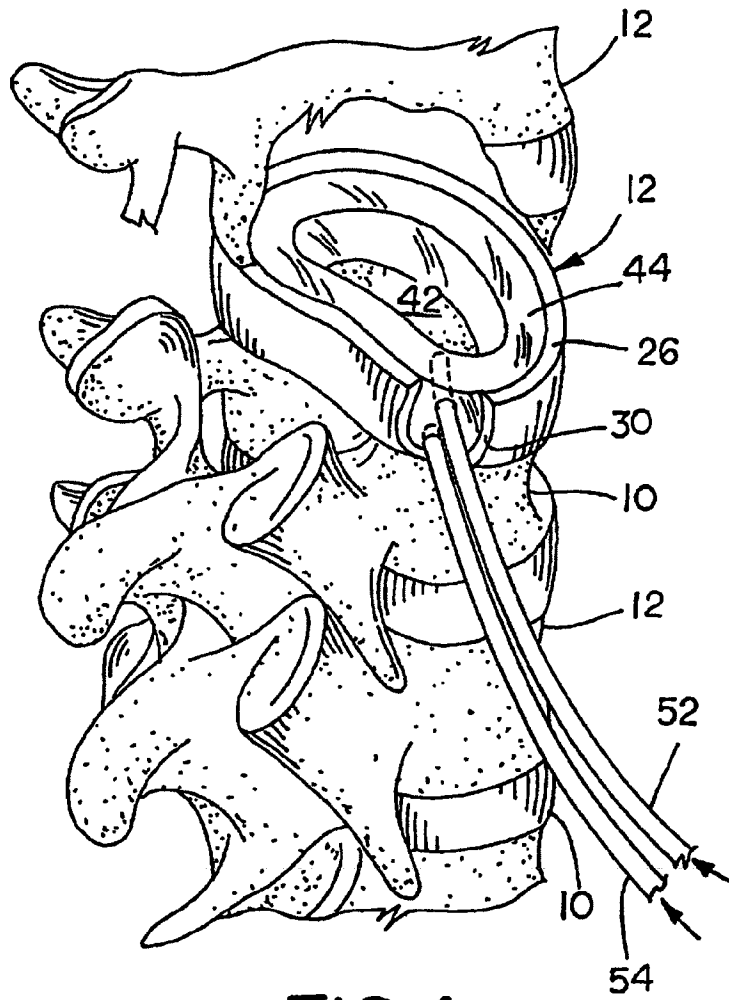

FIG.4

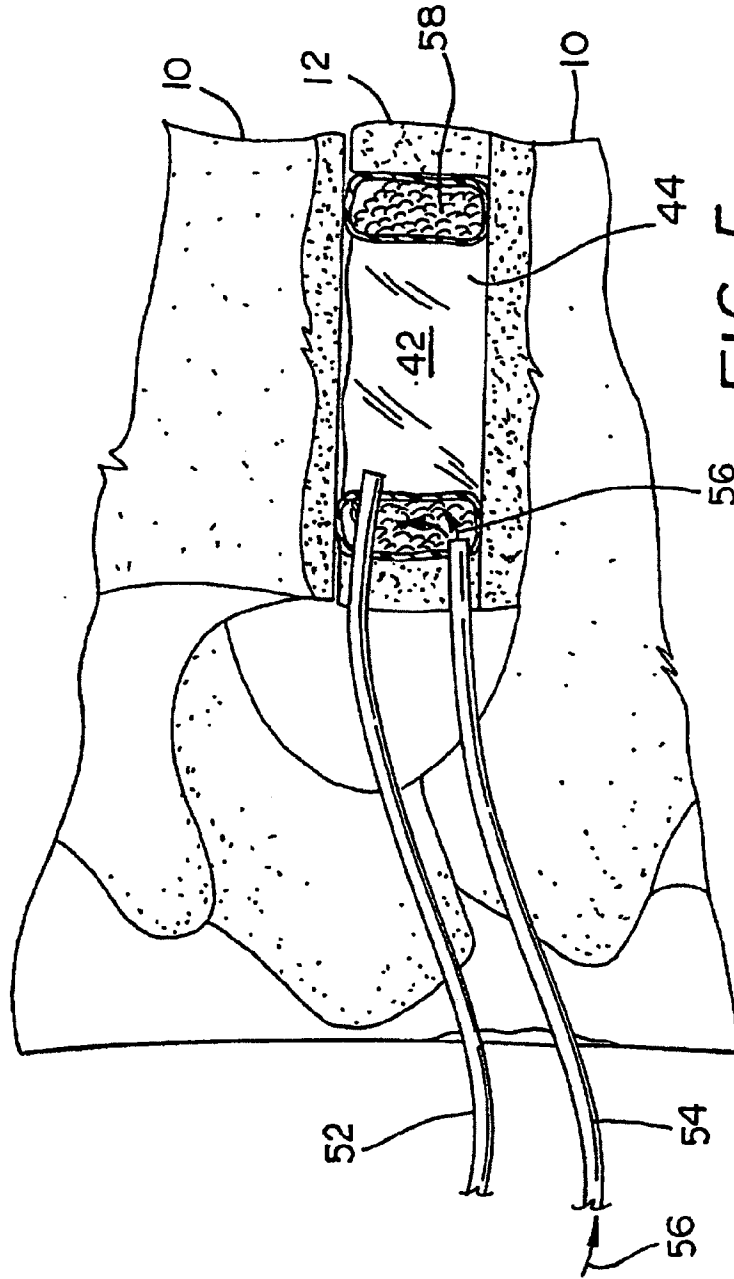

FIG. 5

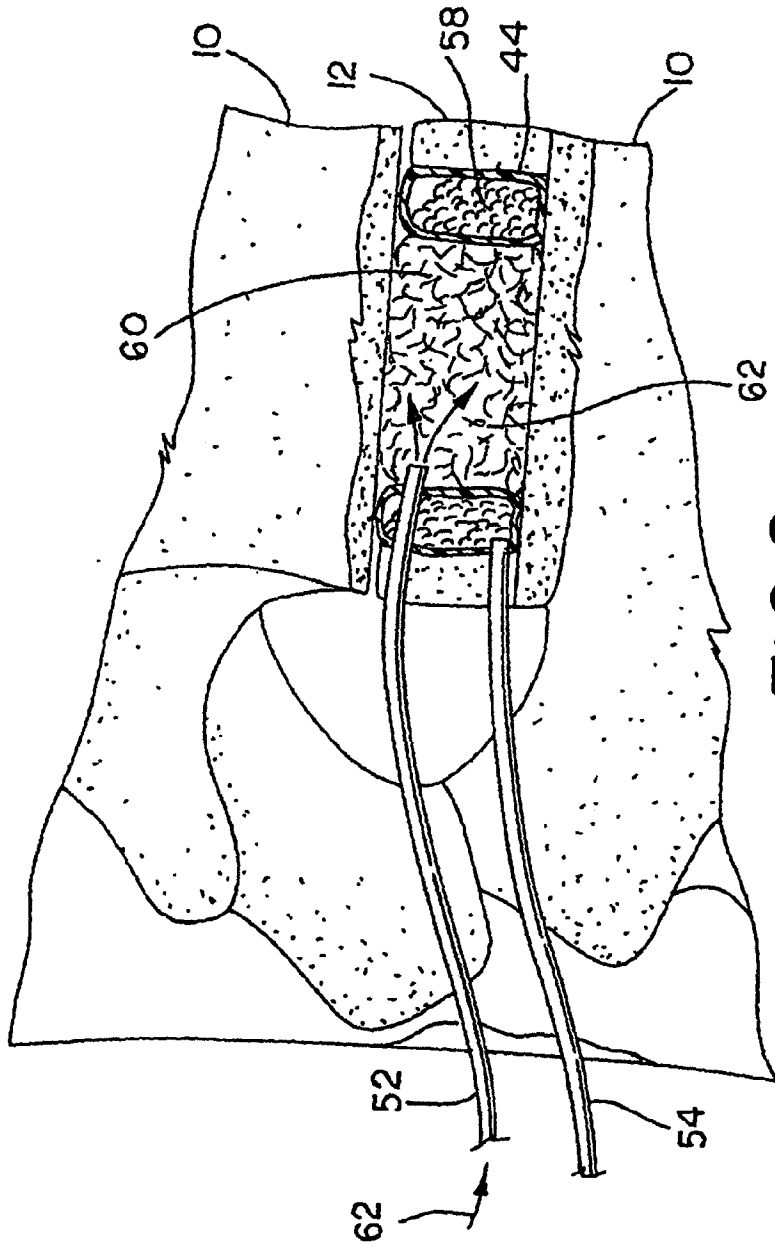

FIG.6

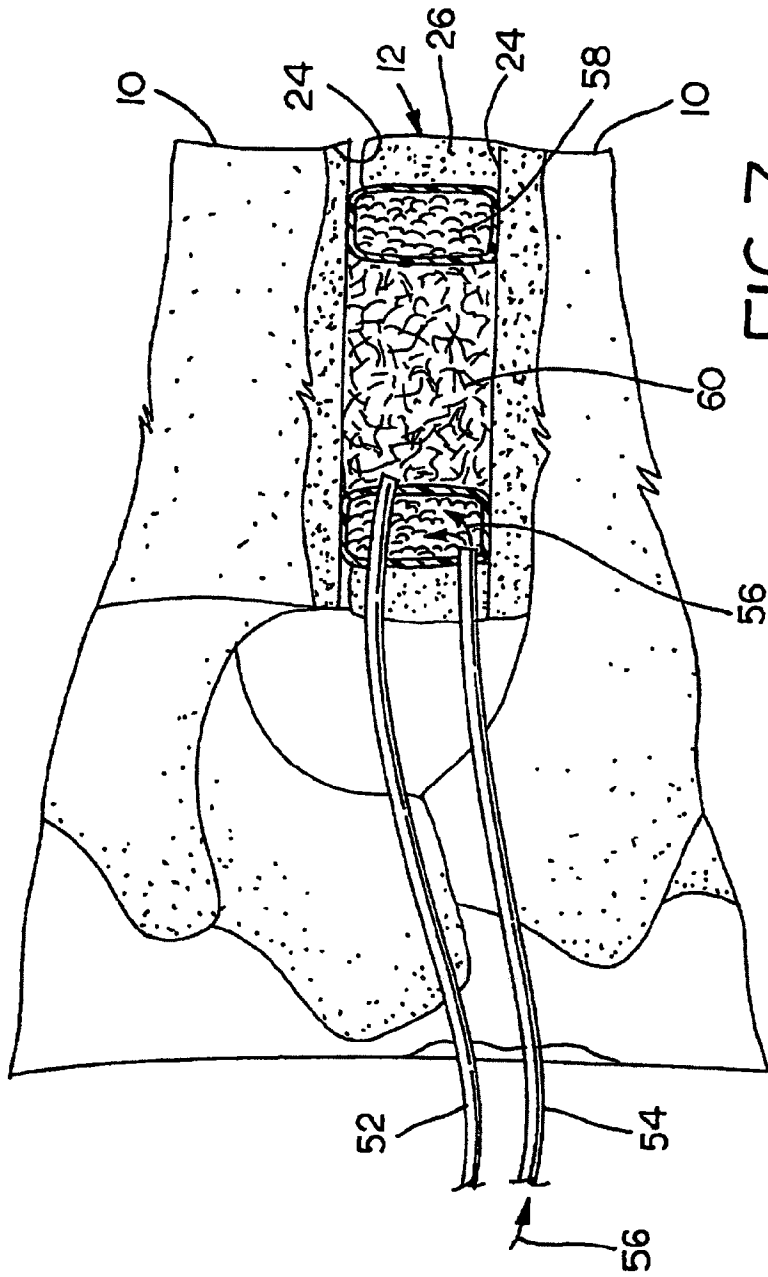
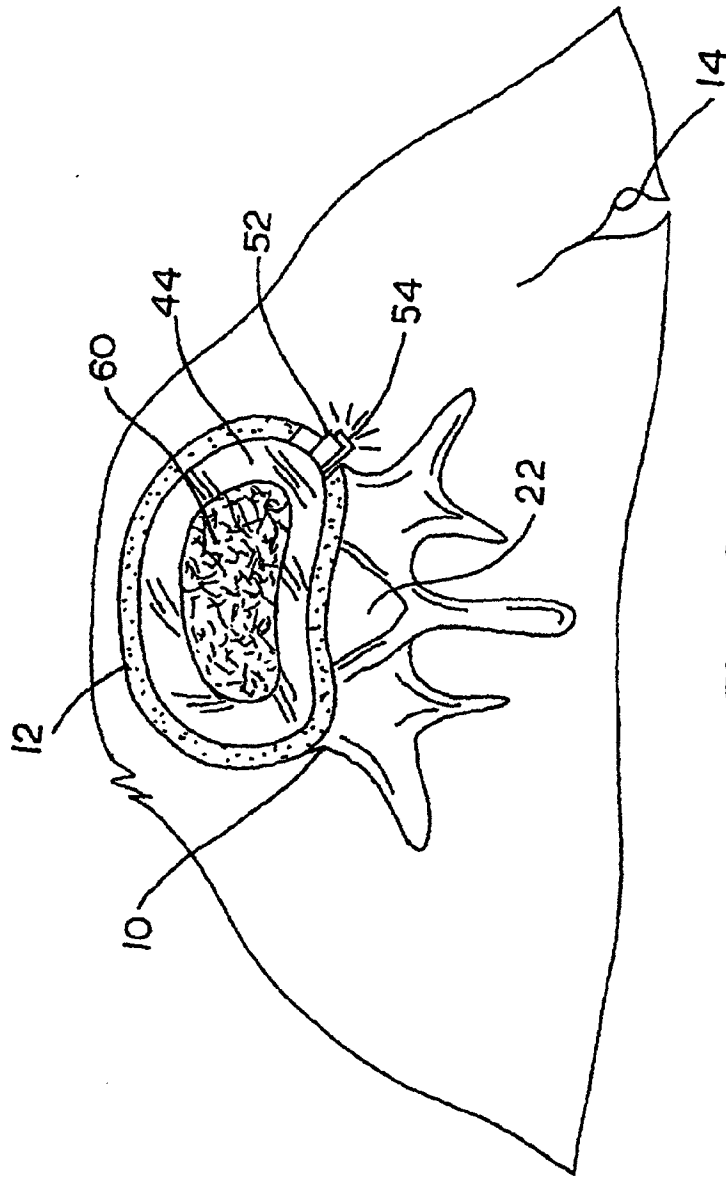

FIG. 7



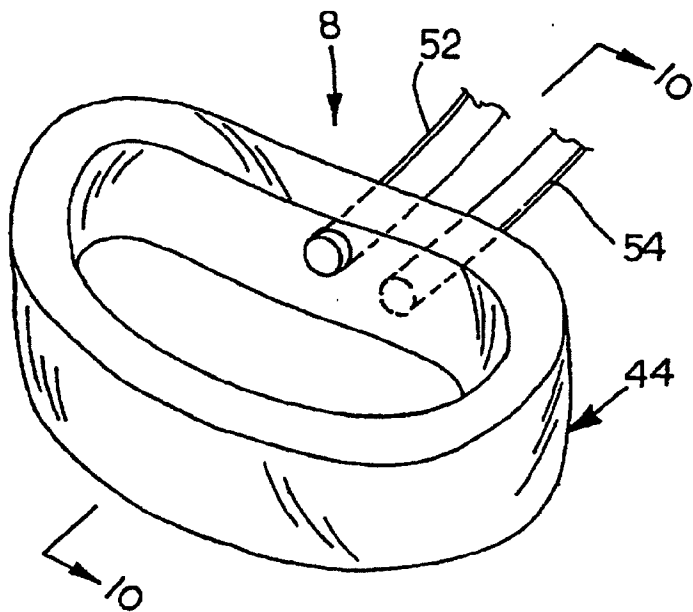

FIG. 9

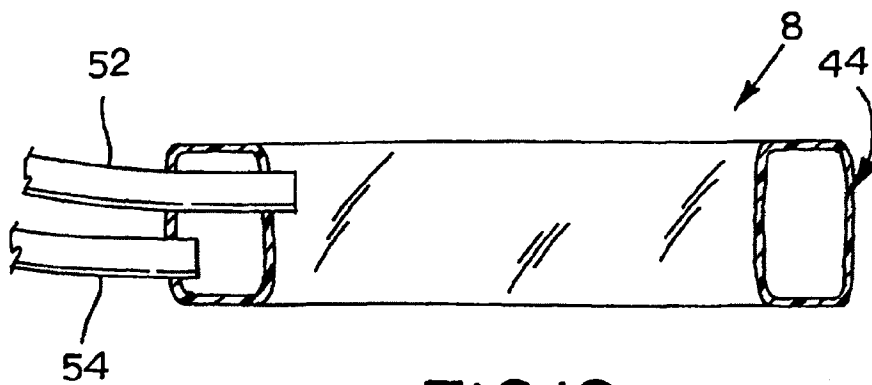

FIG. 10